

**Passo 07:** Encaixar e parafusar o conjunto do encosto (item 02), no 'L' de encosto do conjunto do passo 06, a partir da \* 2ª posição da furação do conjunto do encosto (item 02), conforme ilustrado. Utilizar 4 parafusos (item b).

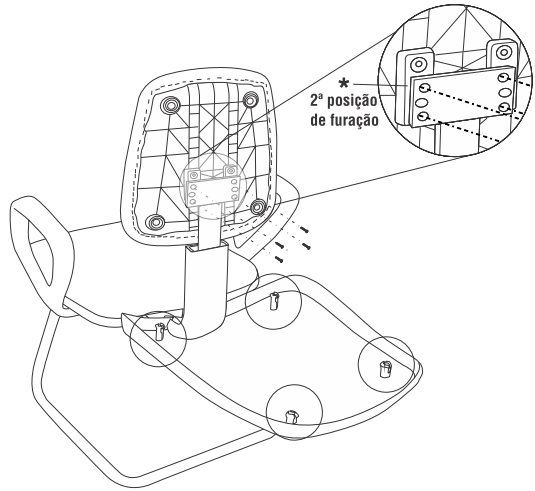

**Passo 08:** Para finalizar a montagem, posicionar a capa do encosto (item 01), já encaixada no passo 06, sobre o conjunto do encosto (item 02) montado no passo 07 e pressionar os encaixes para fixá-los.

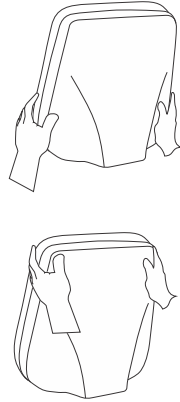

Av. das Indústrias, 337 - Bariri-SP  
+55 14 3662-9000









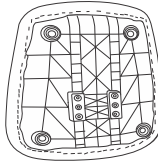

frisokar

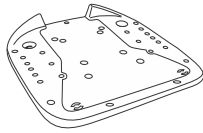
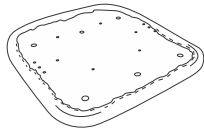
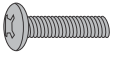
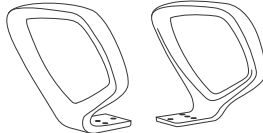
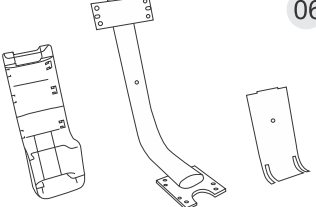
**JOB**  
Linha OPERATIVA FIXA

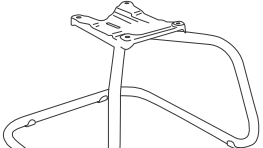

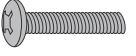
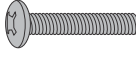
revisão: agosto/2018

<p>01</p>  <p>capa do encosto PP</p>	<p>02</p>  <p>conjunto de encosto</p>	<p>a)</p>  <p>Parafuso Phillips AA FLAN 4X14 (x5)</p>
<p>03</p>  <p>capa do assento</p>	<p>04</p>  <p>conjunto do assento</p>	<p>b)</p>  <p>parafuso PH PAN M6X22 (x4)</p>
<p>05</p>  <p>braços em PU</p>	<p>06</p>  <p>capa inferior 'L' do encosto capa superior</p>	<p>c)</p>  <p>arruela lisa 1/4 (x14)</p>
<p>07</p>  <p>estrutura fixa</p>		<p>d)</p>  <p>parafuso PH PAN M6X12 (x1)</p>
		<p>e)</p>  <p>parafuso PH PAN M6X35 (x4)</p>
		<p>f)</p>  <p>parafuso PH PAN M6X40 (x6)</p>
		<p>g)</p>  <p>calço (x4)</p>
		<p>h)</p>  <p>parafuso PH PAN M6X16 (x4)</p>

**Passo 01:** Montagem do assento:

- a) Sobrepor a capa do assento (item 03) ao conjunto de assento tapeçado (item 04).
- b) Alinhar e encaixar os cliques com o auxílio de uma chave de fenda, para fixar a capa do assento na madeira.
- c) Após o completo encaixe no tópico b), fixar a capa na madeira com 5 parafusos (item a).

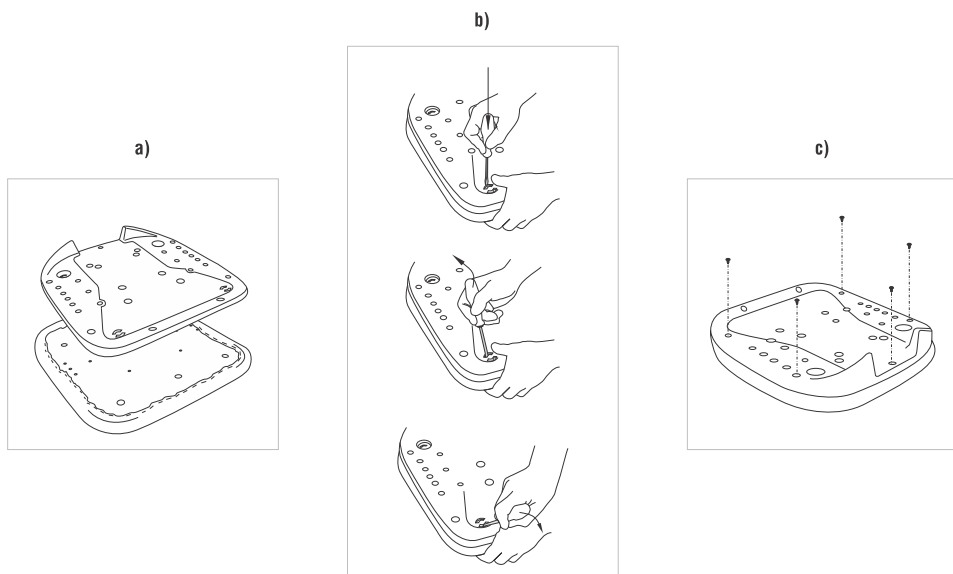

**Passo 02:** Fixar os braços (item 05), no conjunto de assento montado no passo 01. Utilizar 3 parafusos (item f) e 3 arruelas (item c) para cada braço.

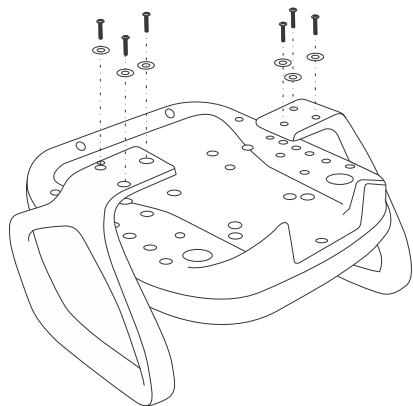

**Passo 03:** Fixar a capa superior do suporte (item 6) ao 'L' do encosto (item 06), utilizar 1 parafuso (item d). Em seguida, encaixar a capa inferior (item 06) e travar o conjunto.

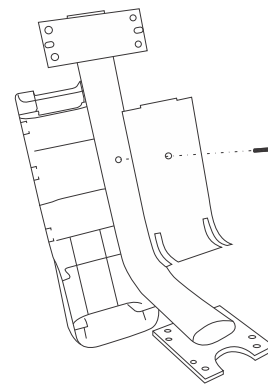

**Passo 04:** Fixar o conjunto de 'L', montado no passo 03, na estrutura fixa (item 07), utilizar 4 parafusos (item h) e 4 arruelas (item c).

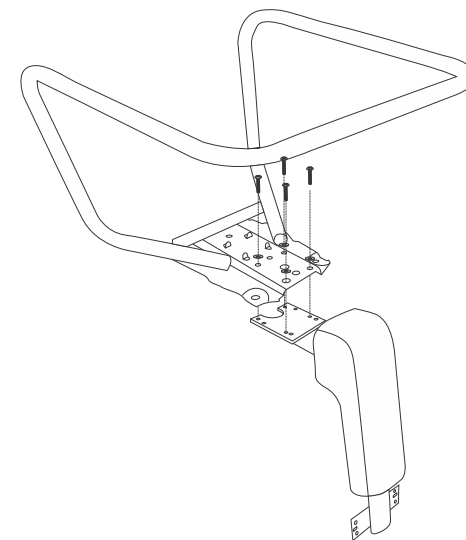

**Passo 05:** Fixar o conjunto montado no passo 04 ao assento do conjunto do passo 02, utilizar 4 parafusos (item e), 4 arruelas (item c) e 4 calços (item g).

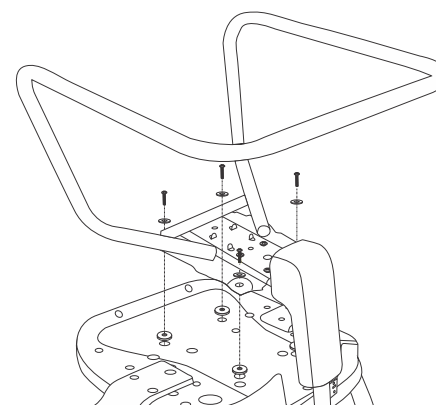

**Passo 06:** Encaixar a capa do encosto (item 01) sobre o 'L' do encosto (item 06), montado no passo 04 e reservar para futura fixação da capa.

Obs. A capa ficará apenas encaixada no 'L' até o passo 07.

